



All-in-one RISC-V AI Compute Engine

Roger Espasa, CEO



In Order
Core



OOO
Core



OOO
Vector
Unit



Tensor
Unit

Old-Style AI Architecture

m = MAC(int)
F = FMAC(float)

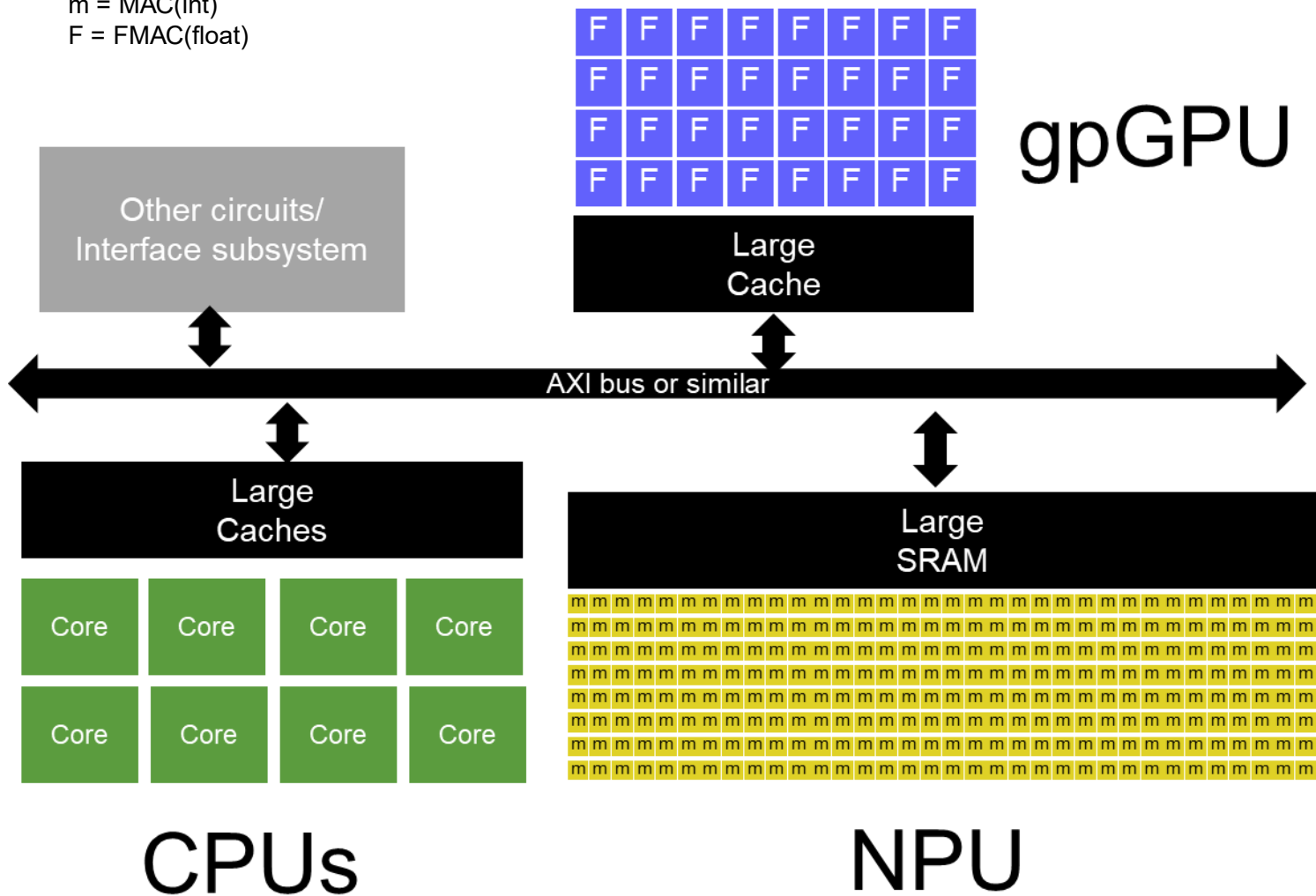

- **Three** Software Stacks
- **DMA-intensive** programming
- **High** Latency & Power
- **SRAM/Cache/Data** Replication
- **Unbalanced** Scaling
- **Not AI Future Proof**

All-in-one: merging Core, NPU, GPU

Optimized Cache

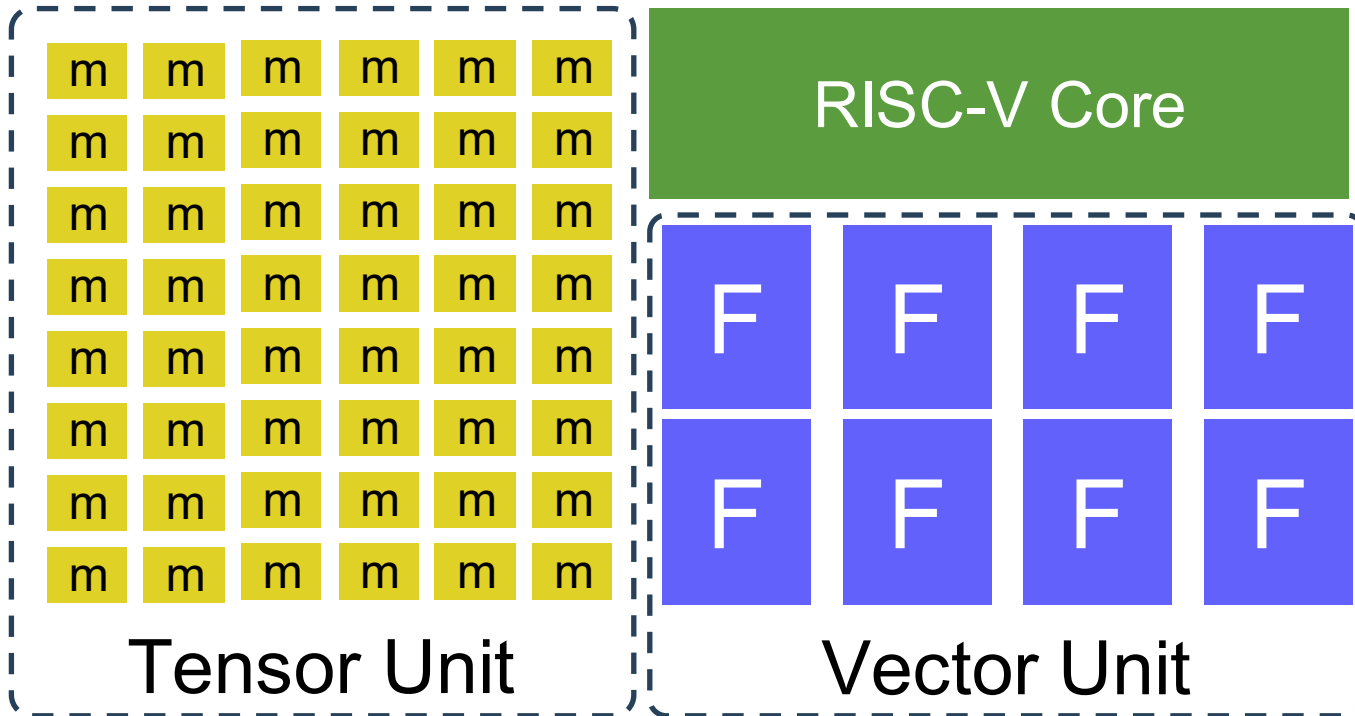

- **Single** software stack
- **DMA-free** programming
- **Zero Latency & Low Power**
- **Optimized/Shared Cache**
- **Balanced Scaling**
- **AI Future-Proof**

All-In-One Block Diagram

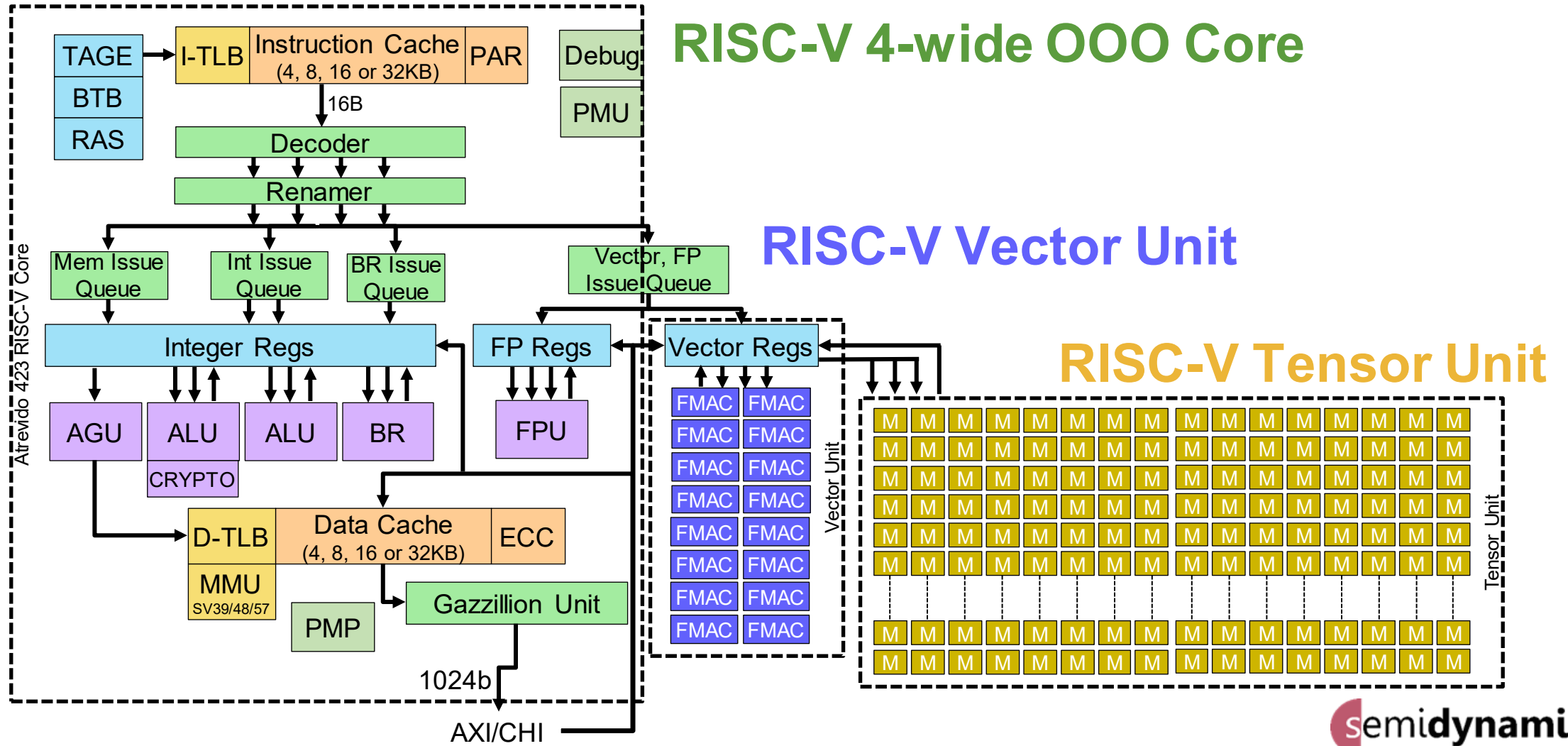

Single Software stack: Matmul in 8 instructions

```
# C tile pre-loaded into v16-v31
loop: vsetvli zero, t4, e16, m2, ta, ma
      vlrs16 v8, (a0), t1
      addi a0, a0, 32
      vsetvli zero, t5, e16, m8, ta, ma
      vlrs16 v0, (a1), t2
      add a1, a1, t3
      vfmxmacc v16, v8, v0
      bltu a1, t6, loop
# Store C tile (v16-v31) back to memory
```

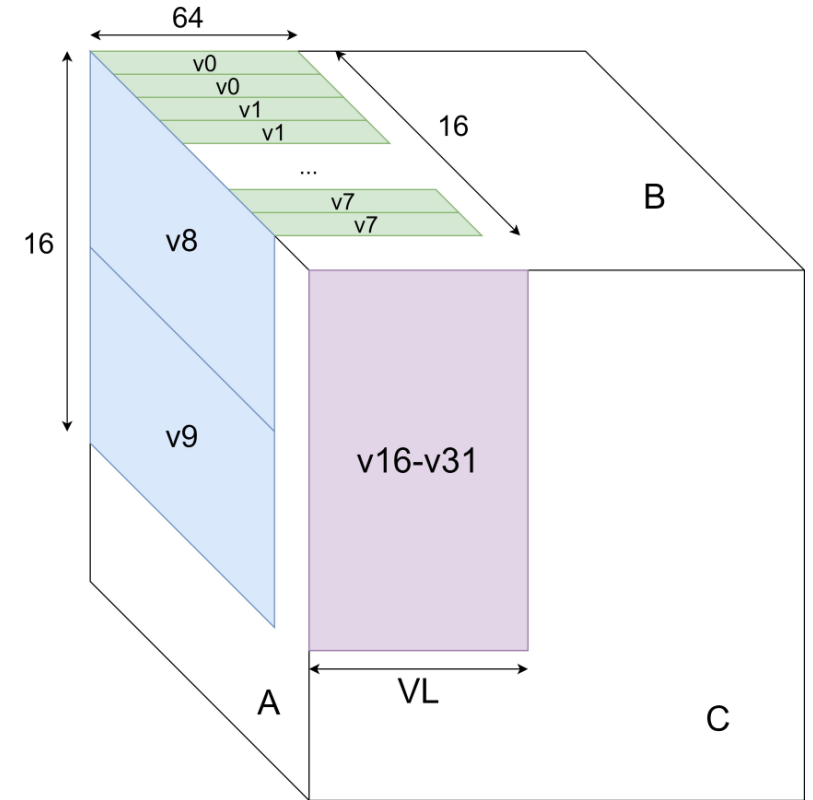

Our Customers AI Concerns

- What **Software stack** do I get with your IP?
- Can I run **today's** AI Models with your IP?
 - Transformers, specifically?
- Can I easily **scale** your solution?
- Can I run **future** AI Models with your IP?
 - I am buying IP today
 - I will be entering the market in 3+ years
 - How do I know the IP will handle the “3-years-from-now” models?

Concern #1: What **Software stack** do I get with the IP?

Semidynamics AI SW Stack

ONNX RT Port to RISC-V + Vector + Tensor



Semidynamics ONNX RT port

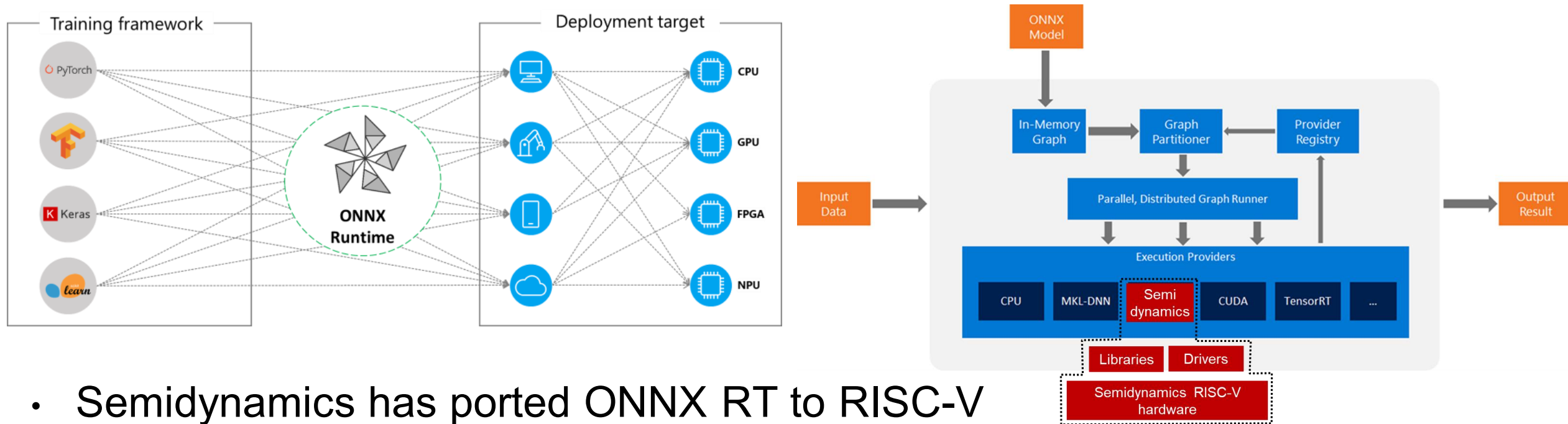

- Semidynamics has ported ONNX RT to RISC-V
 - “Execution Provider” added to ONNX RT
- Semidynamics has optimized the key ONNX operators...
 - ...to use its Tensor unit (for Matrix Multiply & Convolution)
 - ...to use its Vector unit (for Activations like Sigmoid, ...)

Concern #2: Can I run **today's transformers** with your IP?

Running Transformers / LLMs on All-In-One solution

Llama-2, FP16, 7B Parameter



We'll use our 1 TOPS₈ T1 Tensor Unit...

Product	T1	T2	T4	T8
MACs	512	1024	2048	4096
Local SRAM?	No	No	64KB	128KB
INT8 TOPS/GHz	1	2	4	8
INT16 TOPS/GHz	0.5	1	2	4
BF16 TOPS/GHz	0.5	1	2	4
FP16 TOPS/GHz	0.5	1	2	4



We'll use our 128 GOPS₈ V128 Vector Unit...

Product	V128	V256	V512
FMACs	8	16	32
INT8 GOPS/GHz	128	256	512
INT16 GOPS/GHz	64	128	256
BF16 GOPS/GHz	64	128	256
FP16 GOPS/GHz	64	128	256
FP32 GOPS/GHz	32	64	128
FP64 GOPS/GHz	16	32	64



Llama-2

FP16,
7B params

Operators	Scalar	T1	T1+V128
Matmul			
Activations			
Concat			
Sigmoid			
ScatterND			
Div			
Mul			
Slice			
Exp			
Other			
Speedup	1X		

Llama-2

FP16,
7B params

Operators	Scalar	T1	T1+V128
Matmul	99%		
Activations	1%		
Concat	0.11%		
Sigmoid	0.09%		
ScatterND	0.09%		
Div	0.06%		
Mul	0.03%		
Slice	0.03%		
Exp	0.03%		
Other	0.54%		
Speedup	1X		

Llama-2

FP16,
7B params

Operators	Scalar	T1	T1+V128
Matmul	99%	20%	
Activations	1%	80%	
Concat	0.11%	19%	
Sigmoid	0.09%	16%	
ScatterND	0.09%	15%	
Div	0.06%	9.5%	
Mul	0.03%	5.7%	
Slice	0.03%	5.0%	
Exp	0.03%	4.4%	
Other	0.54%	5.4%	
Speedup	1X	170X	

Llama-2

FP16,
7B params

Operators	Scalar	T1	T1+V128
Matmul	99%	20%	55%
Activations	1%	80%	45%
Concat	0.11%	19%	17%
Sigmoid	0.09%	16%	2%
ScatterND	0.09%	15%	17%
Div	0.06%	9.5%	2%
Mul	0.03%	5.7%	2.4%
Slice	0.03%	5.0%	1.3%
Exp	0.03%	4.4%	0.5%
Other	0.54%	5.4%	2.8%
Speedup	1X	170X	470X

Concern #4: Can I easily **scale** your solution?

Scaling up All-in-one solution

How do you scale up further?

- Pick your All-in-one “building block”
 - Pick one of T1, T2, T4, T8
 - Pick one of V128, V256, V512
- Replicate to get **balanced scaling**

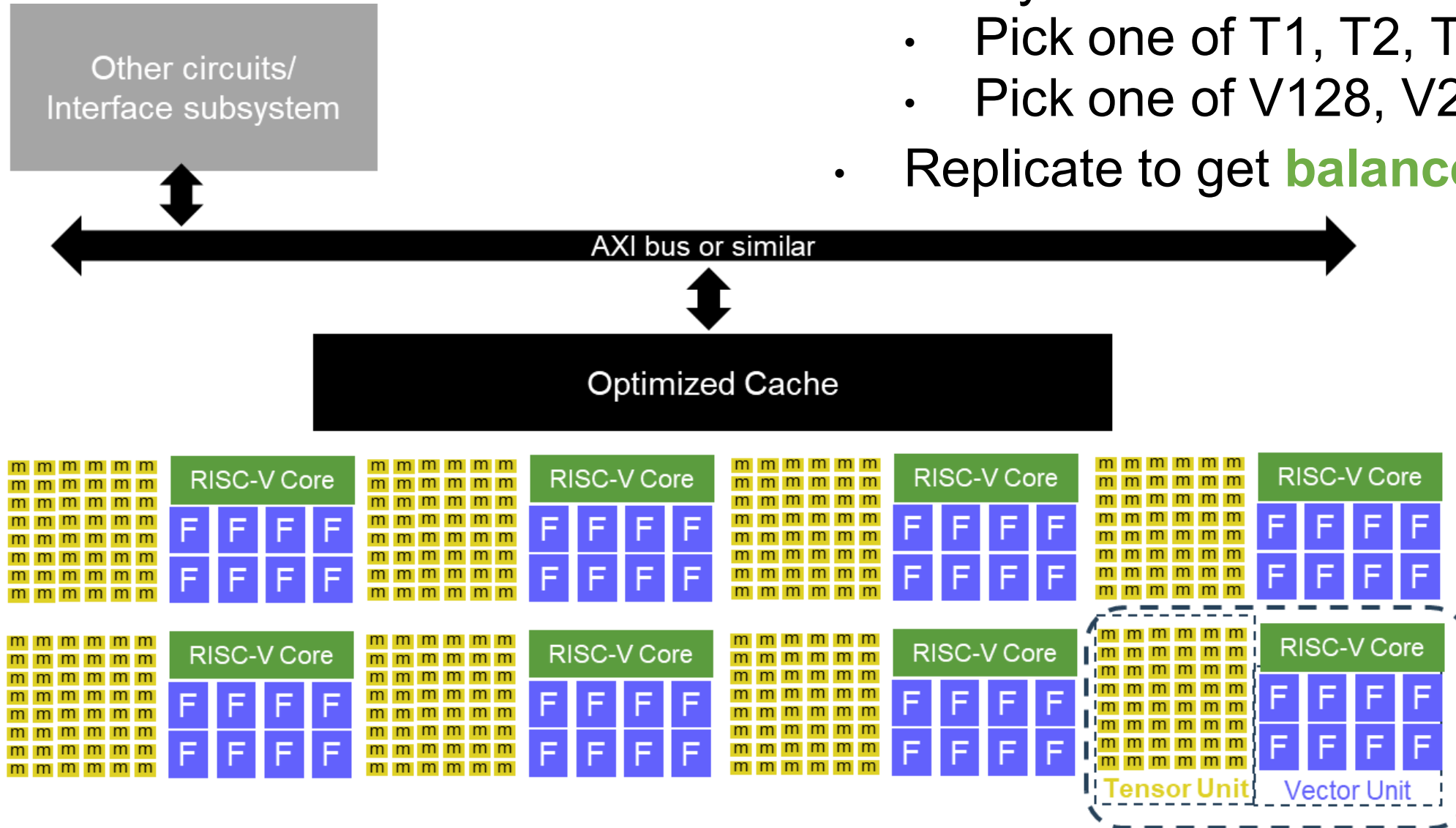

But... where is your ONNX RT SW running?

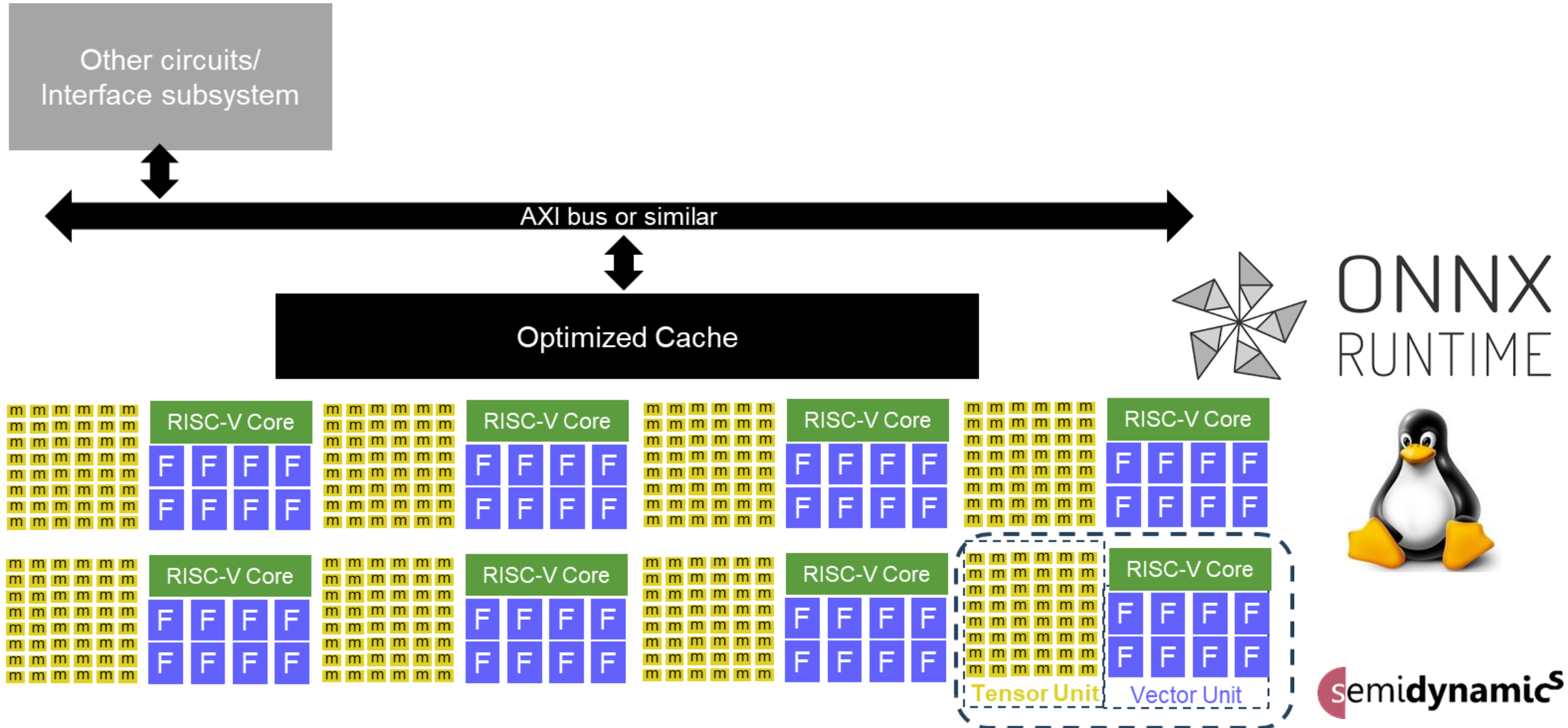

But... where is your ONNX RT SW running?

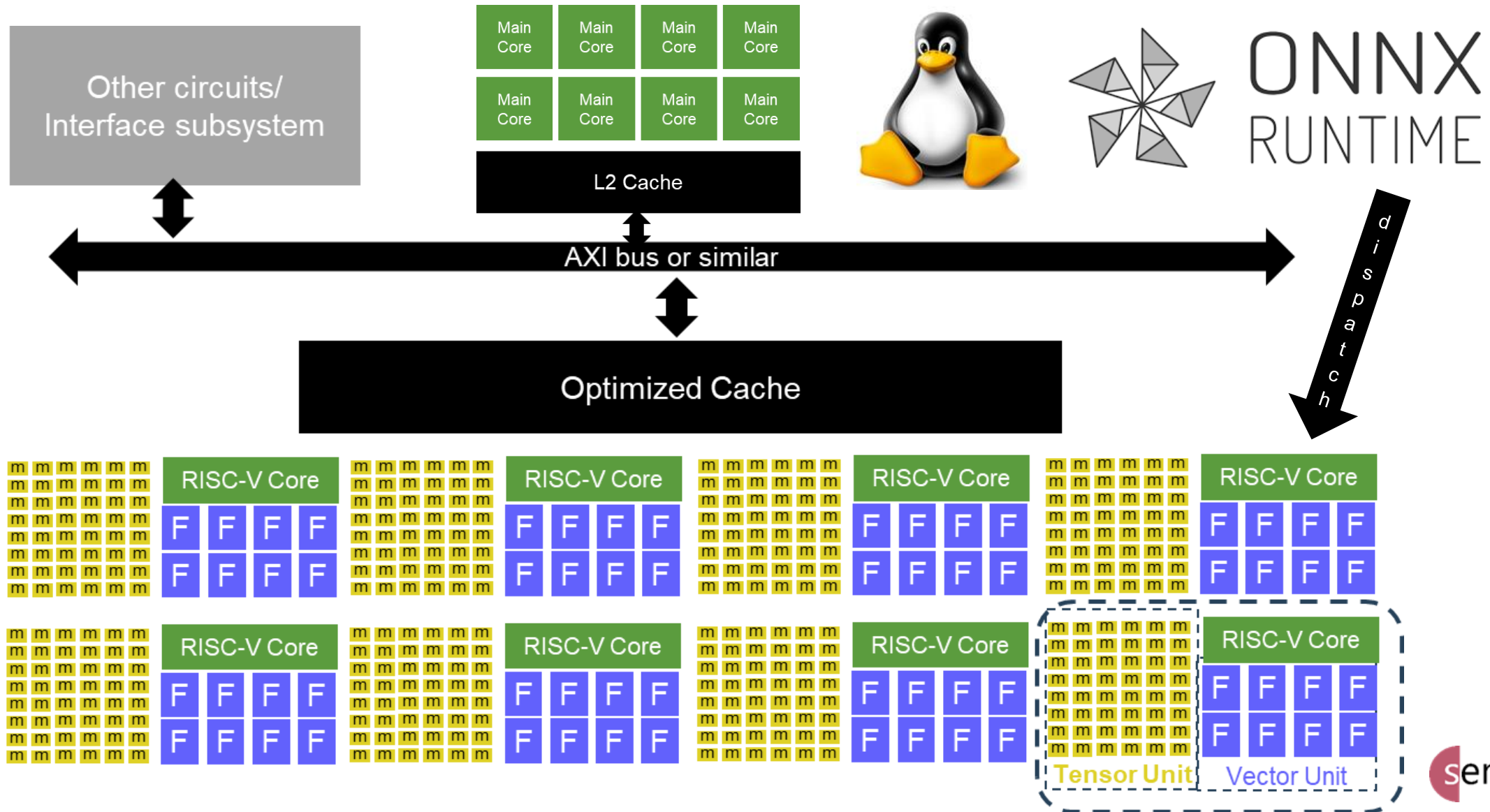

Concern #3: Can I run **future AI models** with your IP?

All-in-one is future-proof

Running Future Models

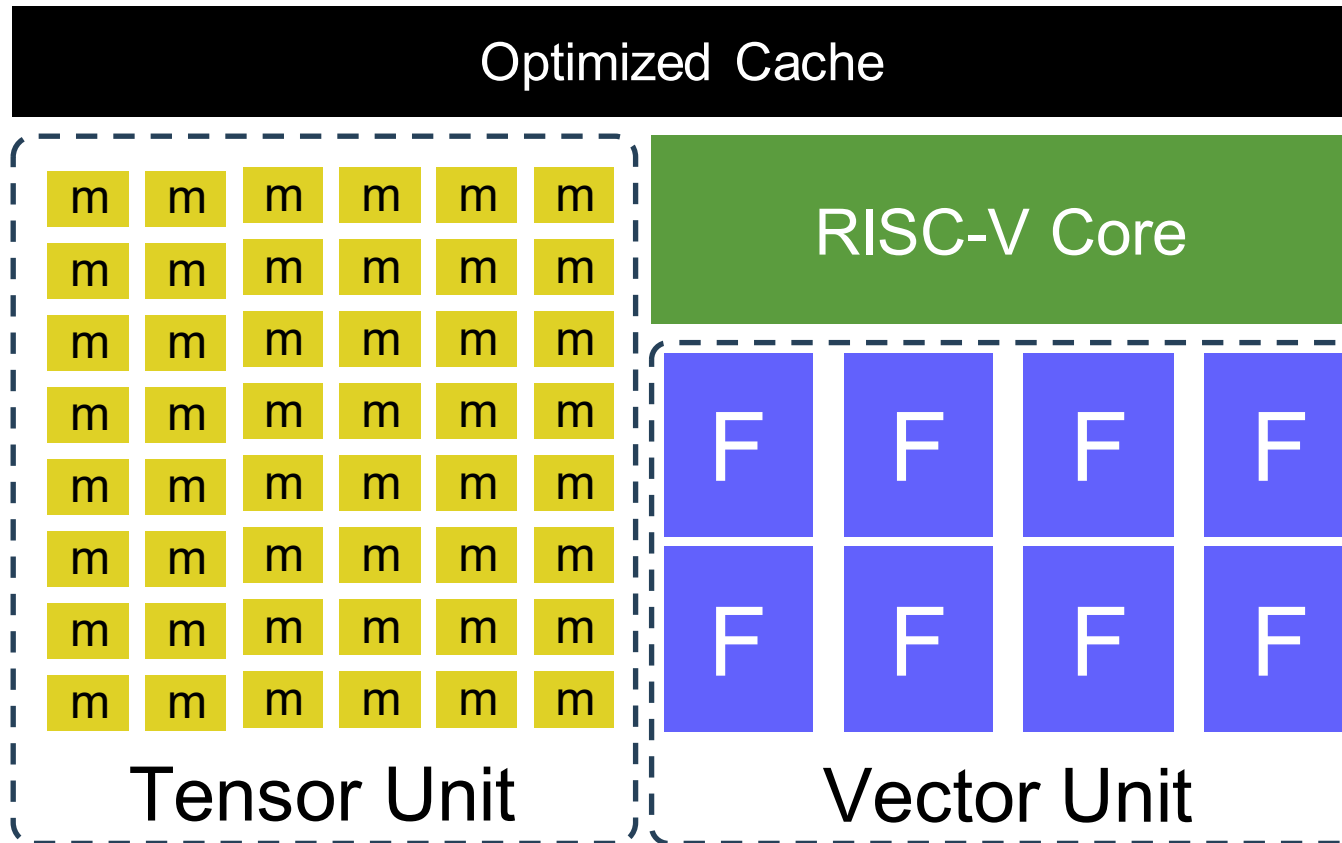

- Vector and Tensor controlled by RISC-V **INSTRUCTIONS**
- RISC-V core has full “if-then-else” and “recursion” capability
 - i.e., Turing-complete
- If the model can be expressed in ONNX, we can run it!

Our Customers AI Concerns - Solved

- What **Software stack** do I get with the IP?
 - ONNX RT optimized for Semidynamics IP
- Can I run **today's** AI Models with current IP?
 - YES, with All-in-One-IP
- Can I run **future** AI Models with current IP?
 - YES, with All-in-One-IP



Let's build the AI future together



Thank you!